

**Input:** 2 or 3 Wire RTD  
**Output:** One 8 Amp DPDT Relay or Two 8 Amp SPDT Relays

- Automatic Leadwire Compensation
- Field Adjustable Setpoints
- Plug-In Design for Fast Installation
- Input LoopTracker® and Alarm Status LEDs
- Alarm Test, Optional Reset Button

**Applications**

- Process Limit Backup Alarm
- Temperature Alarm
- Over, Under, Out-of-Range Alarm

**Temperature Input**

Factory configured, please specify the following  
 Resistance at 0°C, curve, temperature range

RTD types: 10 Ω to 2000 Ω including 100 Ω 0.00385  
 DIN, 100 Ω 0.003916, 100 Ω 0.00392,  
 10 Ω Cu, 1000 Ω Ni-Fe, 120 Ω Ni

Temp. range: °F or °C  
 100°F (55°C) min. span or consult factory

**Leadwire Compensation**

< ±0.05% of span per 1 Ω change in leadwire resistance

**Excitation Current**

10 Ω: 10 mA    100 Ω: 5 mA  
 1000 Ω: 0.5 mA    2000 Ω: 0.2 mA

**LoopTracker**

Variable brightness LED indicates input level and status

**API 1400 G Relay Output**

Two SPDT form C contact sets operating in unison as one  
 DPDT contact set

One setpoint, 12 turn potentiometer, 0-100% of span

Factory configured alarm type

Standard: HI alarm, non-latching, normal acting

Options: LO alarm, latching, reverse acting

**API 1420 G Relay Output**

Two independent SPDT form C contact sets

Two setpoints, two 12 turn potentiometers, 0-100% of span

Factory configured alarm action

Internal jumpers for HI/LO, LO/LO, HI/LO, HI/Hi, LO/Hi

Standard: HI/LO alarm, non-latching, normal acting

Options: LO/LO, HI/Hi, LO/Hi alarms, latching, reverse acting

**Relay Contact Rating**

8 A @ 240 VAC resistive load or 30 VDC resistive load

See graph on other side for relay load ratings

Caution: Do not exceed socket voltage rating

Use an RC snubber for inductive loads

**Deadband**

Alarm trip/reset window is symmetrical about the setpoint

**API 1400 G** 1.0 to 100% of span, 12 turn potentiometer.

**API 1420 G** Fixed at 1% of span, standard

**API 1420 G A** Adjustable deadbands, 1.0 to 100% of span,  
 1 turn potentiometer for each setpoint

**Output Test/Reset Button**

Toggles relay(s) to opposite state when pressed

Resets latching relay with **HT** option, available on 1400 G only

**Response Time**

70 milliseconds typical

**Ambient Temperature Range and Stability**

-10°C to +60°C operating ambient

Better than 0.04% of span per °C stability

**Housing and Sockets**

IP 40, requires installation in panel or enclosure

API 011 or API 011 FS socket

Socket mounts to 35 mm DIN rail or can be surface mounted

**Power**

Standard: 115 VAC ±10%, 50/60 Hz, 2.5 W max.

P option: 85-265 VAC 50/60 Hz, 60-300 VDC, 2.5 W typ.

A230 option: 230 VAC ±10%, 50/60 Hz, 2.5 W max.

D option: 9-30 VDC, 2.5 W typical

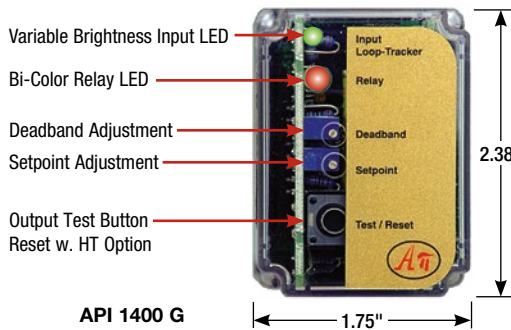

**API 1400 G**

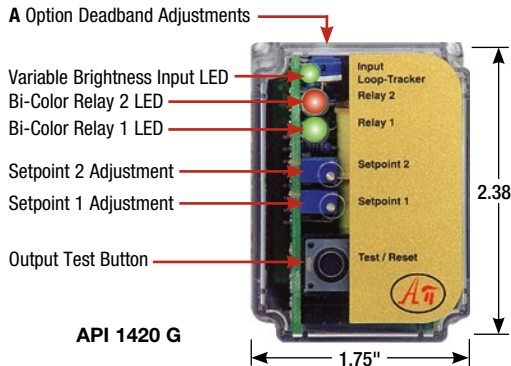

**API 1420 G**

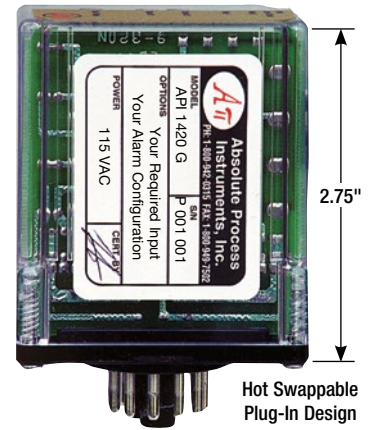

Hot Swappable Plug-In Design



Free Factory I/O Setup!

**Description**

The API 1400 G and API 1420 G are factory configured for an RTD input and provide alarm contact outputs. Heavy duty relay contacts allow the module to directly control high capacity loads.

The API 1400 G provides a single setpoint adjustment and DPDT relay contacts. The alarm output can be factory configured for HI or LO operation, non-latching or latching, normal or reverse acting. Top-accessible potentiometers are used to adjust the alarm setpoint and deadband.

The API 1420 G contains two independent setpoints with two SPDT relay contact outputs. The alarm output can be factory configured for HI/Hi, HI/LO, LO/Hi or LO/LO operation, normal acting or reverse acting. Top-accessible potentiometers are used to adjust each alarm setpoint. Deadband is fixed at 1% of span. Adjustable deadbands are optional.

**LoopTracker and Alarm Status LEDs**

API exclusive features include a LoopTracker LED that varies in intensity with changes in the RTD input signal.

A red/green bi-color alarm status LED (two on the API 1420 G) visually indicate alarm status. These LEDs provide a quick visual picture of your process at all times.

**Output Test/Unlatch**

API's exclusive functional test button can be used to verify the alarm and system operation. The output test button greatly aids in saving time during initial startup and/or troubleshooting.

The HT latching option provides the additional function of unlatching the alarm when the reset button is pressed. The alarm will reset if the alarm condition not longer exists.

Model	Input	Standard Alarm Configuration	Power
API 1400 G	Factory ranged, specify RTD type, curve, temperature range in °F or °C	Single setpoint one DPDT relay HI alarm, non-latching, normal acting	115 VAC
API 1400 G A230			230 VAC
API 1400 G P			85-265 VAC or 60-300 VDC
API 1400 G D			9-30 VDC
API 1420 G	Factory ranged, specify RTD type, curve, temperature range in °F or °C	2 setpoints, 2 SPDT relays HI/LO alarms, non-latching, normal acting	115 VAC
API 1420 G A230			230 VAC
API 1420 G P			85-265 VAC or 60-300 VDC
API 1420 G D			9-30 VDC

**Options—add to end of model number**

**L** 1400 G with LO trip. Alarm trips on decreasing signal.

**HT** 1400 G latching alarm with push button reset

**HP** 1400 G latching alarm with power-off reset. Module power must be turned off to reset alarms

**HH** 1420 G with HI/Hi trip. Alarms trip at their respective trip points on increasing signal.

**LL** 1420 G with LO/LO trip. Alarms trip at their respective trip points on decreasing signal.

**A** 1420 G with adjustable deadbands.

**R** Reverse-acting alarms. Relay coils energized in an alarm condition. No alarm condition with module power off.

**U** Conformal coating for moisture resistance

**Accessories—order as a separate line item**

**API 011** 11-pin socket, DIN rail or surface mount

**API 011 FS** 11-pin finger safe socket, DIN rail or surface mount

**API CLP1** Module hold-down spring for high vibration or mobile applications



API 011 FS  
300 V Rating



API 011  
300 V Rating



API CLP1

## Precautions

**WARNING!** All wiring must be performed by a qualified electrician or instrumentation engineer. See diagram for terminal designations and wiring examples. Consult factory for assistance.

**WARNING!** Avoid shock hazards! Turn signal input, output, and power off before connecting or disconnecting wiring, or removing or installing module.

## Précautions

**ATTENTION!** Tout le câblage doit être effectué par un électricien ou ingénieur en instrumentation qualifié. Voir le diagramme pour désignations des bornes et des exemples de câblage. Consulter l'usine pour assistance.

**ATTENTION!** Éviter les risques de choc! Fermez le signal d'entrée, le signal de sortie et l'alimentation électrique avant de connecter ou de déconnecter le câblage, ou de retirer ou d'installer le module.

API maintains a constant effort to upgrade and improve its products. Specifications are subject to change without notice. See [api-usa.com](http://api-usa.com) for latest product information. Consult factory for your specific requirements.

**WARNING:** This product can expose you to chemicals including lead and nickel, which are known to the State of California to cause cancer or birth defects or other reproductive harm. For more information go to [www.P65Warnings.ca.gov](http://www.P65Warnings.ca.gov)

## Alarm Configuration

API 1400 G relay operation is factory configured. The default configuration is HI alarm normal acting. See model/serial number label for non-standard relay configuration options.

API 1420 G relay operation is factory configured, but internal jumpers can be used to modify the alarm type as follows.

1. Unplug the module from the socket.
2. Remove the 4 screws from the module bottom and remove the plastic case.
3. Unplug the circuit board with the test button from the base.
4. Note location of jumper block at top left of circuit board next to test button. See diagram at right.
5. Place jumpers as indicated for desired alarm operation. The standard HI/LO setting is with one jumper across the two top pins or with no jumper at all. Never place a jumper across the two bottom pins!
6. Replace board, cover, and screws.

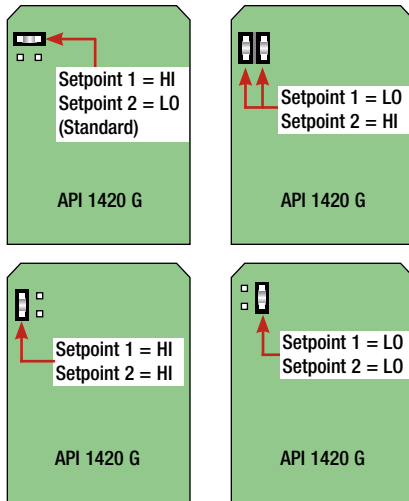

API 1420 G Internal Alarm Configuration Jumpers

## Socket and Mounting

The module installation requires a protective panel or enclosure. Use API 011 or finger-safe API 011 FS socket. See specifications for maximum allowable socket voltages. Note that some relay sockets may have lower voltage ratings. The socket clips to a standard 35 mm DIN rail or can be attached to a flat surface using the two mounting holes.

## Input

The input is factory configured. See the model/serial number label for input type, range, and options.

Correct wiring of 3-wire RTDs must be observed.

Connect 2-wire sensors to terminals 4 and 5 and run a jumper wire from terminal 2 to 5.

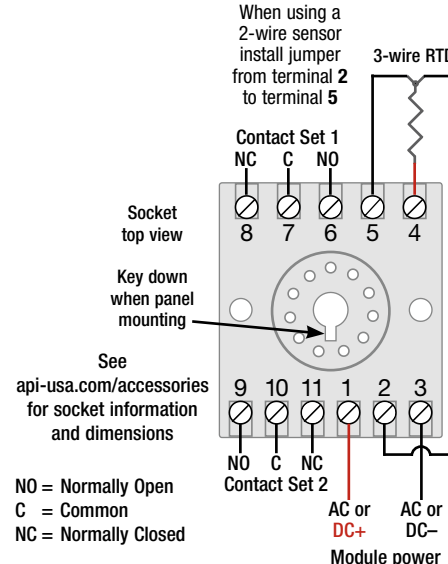

## Relay Output

See wiring diagram for connections. The module does not provide power to the relay contacts.

Inductive loads (motors, solenoids, contactors, etc.) will greatly shorten relay contact life unless an appropriate RC snubber is installed.

## Module Power

Check model/serial number label for module operating voltage to make sure it matches available power.

When using DC power, polarity must be observed. The positive (+) must be wired to terminal 1 and negative (-) must be wired to terminal 3.

## Setpoint

This multi-turn potentiometer (one for each setpoint on the API 1420 G) allows the operator to adjust the level at which the alarm is activated. This control is adjustable from 0 to 100% of the input range.

## Deadband

The API 1400 G deadband potentiometer allows the alarm trip/reset window to be adjusted symmetrically about the setpoint from 1 to 100% of the span.

The deadband is fixed at 1% of span on the API 1420 G. The API 1420 G A with adjustable deadband option allows deadbands to be adjusted symmetrically about each setpoint from 1 to 100% of the span.

Deadband allows the operator to fine tune the point at which the alarm trips and resets. The deadband is typically used to prevent chattering of the relays or false trips when the process signal is unstable or changes rapidly.

## Adjustments

To calibrate the alarm section, set the deadband control to the minimum (counterclockwise). The deadband will be 1.0% of input span in this case.

Set the signal source to a reference that represents the desired trip point.

Adjust the setpoint control to the point at which the relay changes state from a non-alarm to an alarm condition.

If a larger amount of deadband is desired turn the deadband potentiometer clockwise. The deadband is symmetrical about the setpoint; both transition points will change as deadband is increased.

Alternately set the setpoint and deadband until the desired trip/reset points are set.

## Output Test Function

The functional test button toggles the alarm status independent of the input when depressed. It verifies the alarm and system operation. When released, the relays will return to their prior states. This can be used as a diagnostic aid during initial start-up or troubleshooting.

The API 1400 G with the HT latching alarm option, the test button provides the additional function of unlatching the alarm relays provide the alarm condition no longer exists.

## Operation

The green LoopTracker® input LED provides a visual indication that a signal is being sensed by the input circuitry of the module. It also indicates the input signal strength by changing in intensity as the process changes from minimum to maximum.

If the LED fails to illuminate, or fails to change in intensity as the process changes, check the module power or signal input wiring. Note that it may be difficult to see the LEDs under bright lighting conditions.

The bi-color alarm LED provides a visual indication of the alarm status. In all configurations, a green LED indicates a non-alarm condition and a red LED indicates an alarm condition.

**NOTE:** Although the API 1400 G has a pair of relays, these relays will energize and de-energize in unison.

The API 1420 G will accommodate independent relay operations.

## High Alarm (Default, H, or HH)

The alarm relay changes state when the input exceeds the deadband trip point. The relay resets when the input drops below the deadband reset point unless the module has a latching relay option. For a high alarm, the trip point is above the reset point.

## Low Alarm (L or LL)

The alarm relay changes state when the input goes below the deadband trip point. The relay resets when the input exceeds the deadband reset point unless the module has a latching relay option. For a low alarm, the trip point is below the reset point.

## HT Option (API 1400 G Only)

The module has a latching alarm with a push button reset. The Test button or powering the module off can be used to reset the alarm provided the alarm condition no longer exists.

## HP Option (API 1400 G Only)

The module has a latching alarm with a power-off reset. Module power must be turned off to reset alarms. The alarm will reset provided the alarm condition no longer exists.

## Normal Acting Alarms (Standard)

Normal acting alarms energize the relay coils in a non-alarm condition and de-energize them in an alarm condition. This will create an alarm condition if the module loses power.

## Reverse Acting Alarms (R Option)

Reverse-acting alarms energize the relay coils in an alarm condition and de-energize them in a non-alarm condition. There is no alarm condition with module power off.

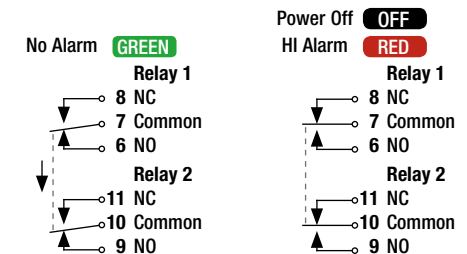

API 1400 G Alarm States with Normal Action HI Alarm

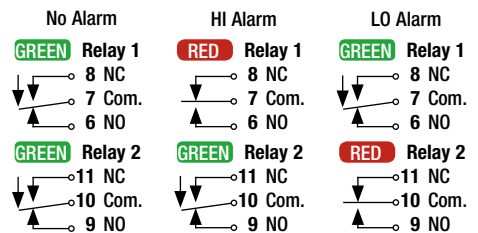

API 1420 G Alarm States with Normal Action HI/LO Alarms

