

# RTD to DC Isolated Transmitters

**Input:** 2 or 3 Wire 10 Ω to 2000 Ω RTD  
**Output:** 0-1 V to 0-10 V, ±1 V to ±10 V, 0-1 mA to 20 mA, 4-20 mA

- Convert Temperature to DC Output
- Zero and Span for Output
- Automatic Leadwire Compensation
- Input and Output LoopTracker® LEDs
- Output Test Button
- Built-In Loop Power Supply for Sink/Source Output

### Applications

- Convert Output From RTD Sensor for PLC Input, Control and/or Validation
- Interface an RTD with Panel Meters, PLCs, Recorders, Data Acq., DCS, & SCADA Systems

### Temperature Input Range

Factory configured, please specify the following  
 Resistance at 0°C, curve, temperature range

RTD types: 10 Ω to 2000 Ω RTDs including  
 100 Ω 0.00385 DIN, 100 Ω 0.003916,  
 100 Ω 0.00392, 10 Ω Cu,  
 1000 Ω Ni-Fe, 120 Ω Ni

Temperature range: °F or °C  
 100°F (55°C) min. span or consult factory

### RTD Typical Excitation Current

10 Ω: 10 mA      100 Ω: 2 mA  
 1000 Ω: 0.5 mA      2000 Ω: 0.2 mA

### Leadwire Compensation

< ±0.05% of span per 1 Ω change in leadwire resistance

### LoopTracker

Variable brightness LEDs indicate I/O loop level and status

### DC Output Range

Factory ranged, please specify output type and range  
 Voltage: 0-1 VDC to 0-10 VDC, 10 mA max  
 Bipolar voltage: ±1 VDC to ±10 VDC  
 Current: 0-1 mADC to 0-25 mADC,  
 4-20 mADC, 20 V compliance,  
 1000 Ω at 20 mA  
 M01 option: Reverse output

### Calibration

Multi-turn zero and span potentiometers for output  
 ±15% of span adjustment range typical

### Output Loop Power Supply

20 VDC nominal, regulated, 25 mADC, max. ripple <10 mVRMS  
 Order EXTSUP option for unpowered mA output

### Output Test

Sets output to test level when pressed  
 Test level factory set to approx. 50% of span  
 Call factory for custom setting

### Output Ripple and Noise

Less than 10 mVRMS

### Linearity

Better than ±0.1% of span

### Ambient Temperature Range and Stability

-10°C to +60°C operating ambient  
 Better than ±0.04% of span per °C stability

### Response Time

70 milliseconds typical

### Isolation

2000 VRMS minimum  
 Full isolation: power to input, power to output, input to output

### Installation Environment

IP 40, requires installation in panel or enclosure  
 Use with API 008 or API 008 FS socket  
 Socket mounts to 35 mm DIN rail or can be surface mounted  
 UL 508C pollution degree 2 environments or better  
 -10°C to +60°C operating ambient

### Power

Standard: 115 VAC ±10%, 50/60 Hz, 2.5 W max.  
 A230 option: 230 VAC ±10%, 50/60 Hz, 2.5 W max.  
 P option: 85-265 VAC 50/60 Hz, 60-300 VDC 2.5 W typ.  
 D option: 9-30 VDC, 2.5 W typical

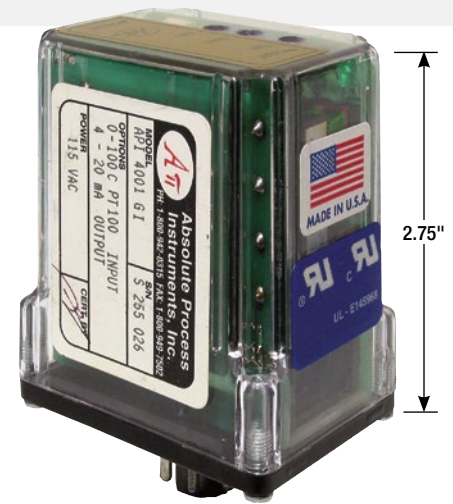
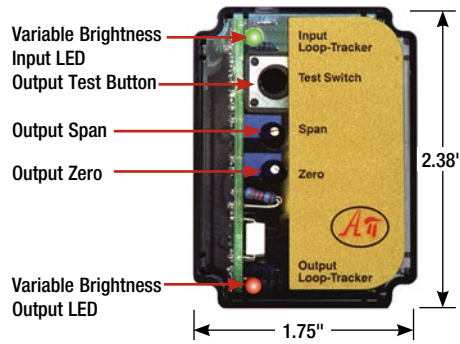

Hot Swappable  
 Plug-In Design



**Quick Link**  
[api-usa.com/4001](http://api-usa.com/4001)

### Description

The API 4001 G L accepts an RTD temperature input and provides an optically isolated and linearized DC voltage or current output. The sensor type, temperature range and output range are factory set and can be specified as required. This provides an economical solution when a temperature sensor signal must be converted to a DC signal.

The temperature input is linearized and amplified, and then passed through an optocoupler to the output stage. Full 3-way isolation (input, output, power) make this module useful for ground loop elimination, common mode signal rejection, and noise pickup reduction.

### Sink/Source Output Options

The API 4001 G L has a 20 VDC loop excitation supply for the output. This power supply can be used to power a passive mA device.

Order the API 4001 G L EXTSUP for an unpowered mA output for devices that are powered externally.

### LoopTracker

API exclusive features include LoopTracker LEDs (green for input, red for output) that vary in intensity with changes in the process input and output signals.

They provide a quick visual picture of your process loop at all times and can greatly aid in saving time during initial startup and troubleshooting.



### Output Test

An API exclusive feature includes an output test button to provide a fixed output (independent of the input) when held depressed. The output test greatly aids in saving time during initial startup and/or troubleshooting.

The test output level is factory set at 50% of output span.

### Mounting

The API 4001 G L plugs into an industry standard 8-pin octal socket sold separately. Sockets API 008 and finger-safe API 008 FS allow either DIN rail or panel mounting.

Model	Input	Output	Power
API 4001 G L	Factory configured Specify RTD type temperature/resistance curve temperature range in °F or °C	Factory configured specify output range in volts or mA	115 VAC 
API 4001 G L A230			230 VAC 
API 4001 G L P			85-265 VAC or 60-300 VDC
API 4001 G L D			9-30 VDC

### Options—add to end of model number

- EXTSUP** Open collector output when a sinking output is required for an external loop supply
- M01** Input/output reversal, such as 20-4 mA out instead of 4-20 mA
- U** Conformal coating for moisture resistance

### Accessories—order as separate line item

- API 008** 8-pin socket
- API 008 FS** 8-pin finger-safe socket
- API CLP1** Module hold-down spring for high vibration or mobile applications



API 008 FS  
 300 V Rating



API 008  
 600 V Rating



API CLP1

**Precautions**

WARNING! All wiring must be performed by a qualified electrician or instrumentation engineer. See diagram for terminal designations and wiring examples. Consult factory for assistance.  
 WARNING! Avoid shock hazards! Turn signal input, output, and power off before connecting or disconnecting wiring, or removing or installing module.

**Précautions**

ATTENTION! Tout le câblage doit être effectué par un électricien ou ingénieur en instrumentation qualifié. Voir le diagramme pour désignations des bornes et des exemples de câblage. Consulter l'usine pour assistance.

ATTENTION! Éviter les risques de choc! Fermez le signal d'entrée, le signal de sortie et l'alimentation électrique avant de connecter ou de déconnecter le câblage, ou de retirer ou d'installer le module.

API maintains a constant effort to upgrade and improve its products. Specifications are subject to change without notice. See api-usa.com for latest product information. Consult factory for your specific requirements.

 **WARNING:** This product can expose you to chemicals including lead and nickel, which are known to the State of California to cause cancer or birth defects or other reproductive harm. For more information go to www.P65Warnings.ca.gov

**Socket and Mounting**

The module installation requires a protective panel or enclosure. Use API 008 or finger-safe API 008 FS socket.

The socket clips to a standard 35 mm DIN rail or can be attached to a flat surface using the two mounting holes.

**Electrical Connections**

The sensor type and temperature range are factory configured. See the model/serial number label for power requirements, sensor type, temperature range and options.

Polarity must be observed for output wiring connections. If the output does not function, check wiring polarity.

**3 Wire RTD Input**

The temperature sensor is connected to the 8-pin socket as shown in the wiring diagrams.

You may wish to check the RTD sensor with an ohmmeter before connecting since RTD wire color coding varies.

The red (or black) wire is connected to terminal 6 and the other two wires with the same color are connected to terminals 4 and 5.

**2 Wire RTD**

The temperature sensor is connected to the 8-pin socket as shown in the wiring diagrams.

When using a 2-wire sensor install a jumper from terminal 4 to terminal 5.

One sensor wire is connected to terminal 6 and the other is connected to terminals 4 or 5.

**Signal Output Terminals**

Polarity must be observed when connecting the signal output to the load. The positive connection (+) is connected to terminal 7 and the negative (-) is connected to terminal 8.

Note that with a current output the module provides power to the output loop unless option EXTSUP was ordered for a sinking output requirement.

**Module Power**

Check model/serial number label for module operating voltage to make sure it matches available power.

AC power is connected to terminals 1 and 3.

For DC powered modules, polarity MUST be observed.

Positive (+) is wired to terminal 1

Negative (-) is wired to terminal 3

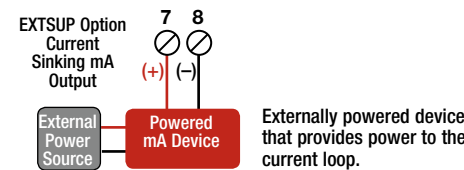
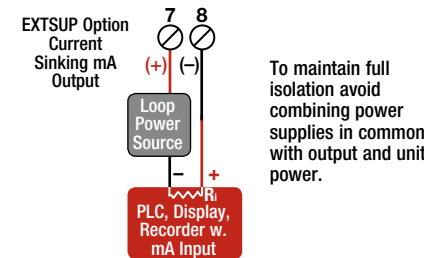
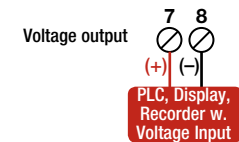
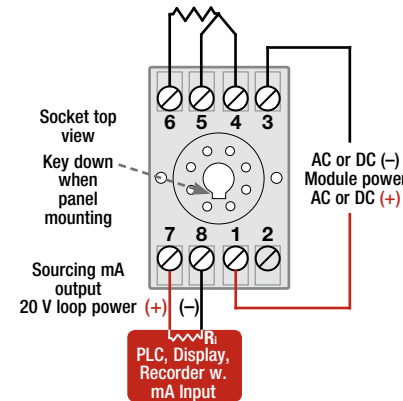
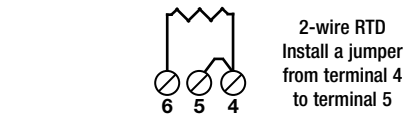

**Calibration**

The API 4001 G L is factory configured to your exact input and output requirements.

Input and output ranges are listed on module labels. Input changes require factory modification.

Top-mounted Zero and Span potentiometers can be used should fine-tuning of the output be necessary.

1. Apply power to the module and allow a minimum 20 minute warm up time.
2. Using an accurate temperature simulator, provide an input to the module equal to the minimum input required for the application.
3. Using an accurate measurement device for the output, adjust the Zero potentiometer for the exact minimum output desired. The Zero control should only be adjusted when the input signal is at its minimum. This will produce the corresponding minimum output signal. For example: 4 mA for a 4-20 mA output or -10 V for a ±10V output.
4. Set the input at maximum, and then adjust the Span pot for the exact maximum output desired. The Span control should only be adjusted when the input signal is at its maximum. This will produce the corresponding maximum output signal. Example: for 4-20 mA output, the Span control will provide adjustment for the 20 mA or high end of the signal.
5. Repeat adjustments for maximum accuracy.

**Output Test Function**

When the Test button is depressed it will drive the output with a known good signal that can be used as a diagnostic aid during initial start-up or troubleshooting. When released, the output will return to normal.

The Test Cal. level is factory set to approximately 50% output. Example: If you are checking a 4-20 mA current loop, when the push button is held depressed, the output from the module will be approximately 12 mA.

**Operation**

The input circuitry in both models provides a constant-current excitation source to the RTD and automatically cancels lead-wire effects. The temperature signal is amplified and passed through an optical isolator. Then is passed to the output stage where it is corrected for the inherent non-linearity of the specified RTD type and scaled to the desired output range.

The green LoopTracker® input LED provides a visual indication that a signal is being sensed by the input circuitry of the module. It also indicates the input signal strength by changing in intensity as the process changes from minimum to maximum.

If the LED fails to illuminate, or fails to change in intensity as the process changes, check the module power or signal input wiring. Note that it may be difficult to see the LEDs under bright lighting conditions.

The red LoopTracker output LED provides a visual indication that the output signal is functioning. It becomes brighter as the input and output changes from minimum to maximum.

For a current output, the red LED will only light if the output loop current path is complete. For either current or voltage outputs, failure to illuminate or a failure to change in intensity as the process changes may indicate a problem with the module power or signal output wiring.

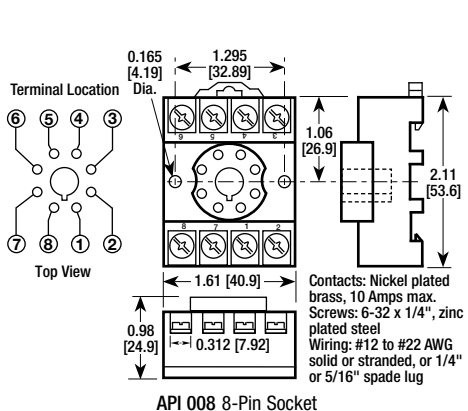

API 008 8-Pin Socket

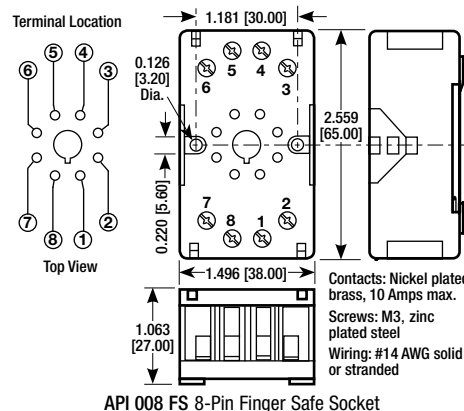

API 008 FS 8-Pin Finger Safe Socket