

100 Ω RTD to DC Isolated Transmitter

K109PT 

Input: 100 Ω RTD, 385 Curve
Output: 0-5 V, 1-5 V, 0-10 V, 10-0 V, 20-0 mA, 0-20 mA, 20-4 mA, 4-20 mA

- Only 6.2 mm Wide
- Convert Temperature to DC Output
- DIP Switch Configuration
- Full 3-Way Isolation
- Bus Power Options

Applications

- Convert Output From RTD Sensor for PLC Input, Control and/or Validation
- Interface an RTD with Panel Meters, PLCs, Recorders, Data Acq., DCS, & SCADA Systems

Description

The K109PT converts a Pt100 Ohm sensor signal with 2, 3, or 4 wires to a standard isolated mA/V output signal. The K109PT is a low cost isolator/converter for Platinum RTDs. The compact 0.25" (6.2 mm wide) size saves considerable panel space. Input and output are completely configurable via DIP switches.

Specifications

Input Type

Pt100: 2, 3, or 4 wire, 385 curve

Input Temperature Range

-150 to 650°C, (-238 to 1202°F), 50°C min. span

Output

0-20 mA, 20-0 mA, 4-20 mA, 20-4 mA
 Sourcing mA output, 10 V, max. load: 500 Ω
 0-10 V, 10-0 V, 0-5 V, 1-5 V, min. load: 2 kΩ

Response

<50 ms typ., <200 ms with filter

LED Indicators

Sensor fault, setting error, internal error

Accuracy

±0.1% of span or (40 K / D_{temp} + 0.05) % (measurement range), temperature coefficient 100 ppm

Configuration

DIP switches

Conversion

Input A/D conversion: 14 bit
 Output A/D conversion: 16 bit, floating point 32 bit

Sensor Current

<900 μA pulsed

Lead Resistance

Max. 20 Ω per wire

Isolation

Full 3-way isolation: input, output, power
 Galvanic and optocoupler
 1500 V_{RMS} 1 minute isolation
 Hot swappable

Over-Range Output

Over-range 102.5% FS, malfunction 105% of FS
 Current output protection approximately 25 mA

Ambient Conditions

-20°C to +65°C operating
 -40°C to +85°C storage
 10 to 90% RH non-condensing

Connections

24 to 14 AWG wire size stripped 5/16"
 Spring clamp terminals or DIN rail K-BUS for power

Housing

IP 20, requires installation in panel or enclosure
 Mounts to standard 35 mm DIN rail
 1.7 ounces (50 grams)

Power

19.2 to 30 VDC via terminals or K-bus, 500 mW max typ.

Dimensions

2.5" H x 0.25" W x 4" D (93.1 x 6.2 x 102.5 mm)

Standards

CE, UL-UR CSAEN 50081-2, EN 50082-2, EN 61010-1, EN 60742, EN 61000-6-4, EN 61000-6-2

Free Factory I/O Setup!

Quick Link api-usa.com/k-line

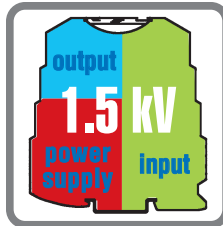
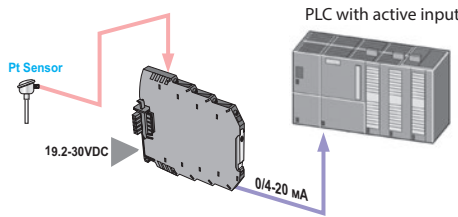

3-Way Isolation

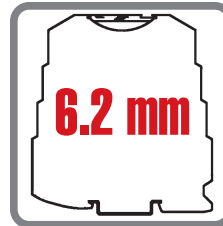

Narrow 0.25" Width

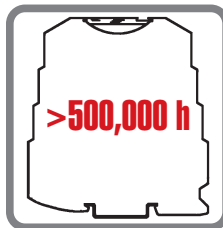

Long MTBF

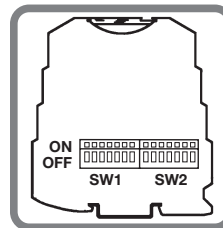

Versatile DIP Switch Setup



Best Accuracy



Low Power Consumption



Actual Size

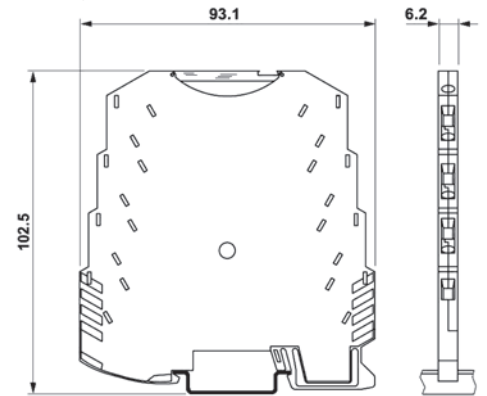

K-Bus Power



K-BUS Backplane power connection snaps into DIN rail.

More Slim Transmitters

- K109TC** Thermocouple to DC transmitter
- K121** Universal temperature/mA/V/Ohm to DC
- K109UI** DC to DC isolator/converter
- K107A** RS485 - RS485 serial amplifier/Isolator
- K107B** RS232 - RS485 serial isolator/converter
- K107USB** USB - RS485 isolator/converter

Call 1-800-942-0315 to place your order!	
Model	Description
K109PT	RTD transmitter for Pt100 sensor. User configurable temperature range and mA or voltage output. 19.2-30 VDC powered.
K-BUS	DIN rail power connector system. See api-use.com/kbus

Precautions

WARNING! All wiring must be performed by a qualified electrician or instrumentation engineer. See diagram for terminal designations and wiring examples. Consult factory for assistance.

WARNING! Avoid shock hazards! Turn signal input, output, and power off before connecting or disconnecting wiring, or removing or installing module.

Précautions

ATTENTION! Tout le câblage doit être effectué par un électricien ou ingénieur en instrumentation qualifié. Voir le diagramme pour désignations des bornes et des exemples de câblage. Consulter l'usine pour assistance.

ATTENTION! Éviter les risques de choc! Fermez le signal d'entrée, le signal de sortie et l'alimentation électrique avant de connecter ou de déconnecter le câblage, ou de retirer ou d'installer le module.

DIP Switch Settings

Before installation set the SW1 and SW2 DIP switches for your application as indicated in the tables at right.

Factory configuration with all DIP switches OFF is as follows: 3 wire Pt100 sensor, input filter ON, output signal 4-20 mA, range start 0°C, full-scale 100°C, upscale burnout, input over-range ON.

Installation

The housing clips to a standard 35 mm DIN rail and requires installation in a protective enclosure. Install module in a vertical orientation and position in the lower part of the panel away from heat sources or objects that may block air flow.

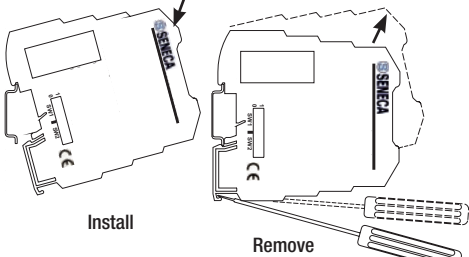

1. Tilt the front of module upward and clip the upper mount to the top edge of the DIN rail.
2. Push front of module downward until lower mount snaps into place.

To Remove: Avoid shock hazards! Turn input, output, and power off before removing module.

1. Use small screwdriver to pry to lower clip away from the DIN rail.
2. Tilt the front of module upward to remove.

Inserting Wires

Use a flat blade screwdriver with a blade about 1/8" W to depress wiring spring clip for each connection.

1. Insert screwdriver at a nearly vertical angle into the square opening next to desired round terminal. Make sure the screwdriver goes under the spring clip and not into the clip opening.
2. Push the screwdriver down and in, (or up and in for lower terminals). The wire clip moves up exposing the opening in the round terminal opening.
3. Insert wire into round terminal hole, then remove the screwdriver and make sure wire is secure.

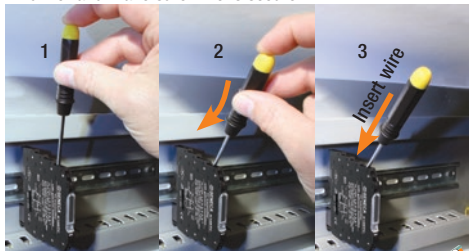

Electrical Connections

See the wiring diagram below. Use copper conductors and a Class 2 power supply. When using an isolated voltage/limited power supply, a max. 2.5 A fuse must be installed.

K-Line signal conditioners can be powered by a 24 VDC power supply connected to the module terminals or the K-Bus DIN rail power supply connector that can power up to 16 devices using up to 400 mA. The K-BUS eliminates the need to connect the power supply to each module. See api-usa.com/kbus.

In order to reduce the module's heat dissipation, either use the voltage output or the current output with a load of > 250 Ω.

Polarity must be observed for output wiring connections. If the output does not function, check wiring and polarity.

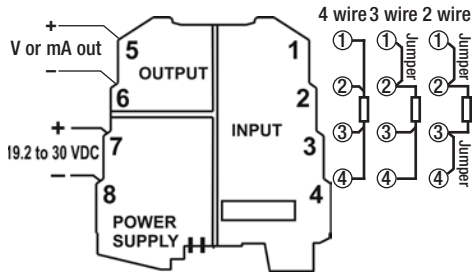

LED Indicators

LED	Function
Rapid flashing 3 times per second	Module internal malfunction
Slow flashing 1 time per second	DIP switch setting error
Steady light	Pt100 wire connection malfunction or 3rd wire resistance too high

Switch 1 Settings

No indication in table = DIP switch is set to OFF.

SW1	1	Pt100 Wiring		
	ON	2 or 4 wires		
		3 wires		
SW1	2	Input Filter		
	ON	No		
		Yes (input response time approx. 200 ms)		
SW1	3	4	5	Output Signal
				4-20 mA
	ON			0-20 mA
		ON		20-4 mA
	ON	ON		20-0 mA
			ON	0-10 VDC
		ON	ON	10-0 VDC
	ON	ON	ON	0-5 VDC
	ON	ON	ON	1-5 VDC
SW1	6	7	8	Measurement Range Start
				0°C 32°F
	ON			-10°C 14°F
		ON		-20°C -4°F
	ON	ON		-30°C -22°F
			ON	-40°C -40°F
	ON		ON	-50°C -58°F
		ON	ON	-100°C -148°F
	ON	ON	ON	-150°C -238°F

Measurement Full Scale: SW2 1 through 6							
1	2	3	4	5	6	°C	°F
						0°C	32°F
ON						5°C	41°F
	ON					10°C	50°F
		ON				15°C	59°F
			ON			20°C	68°F
ON		ON				25°C	77°F
	ON	ON				30°C	86°F
ON	ON	ON				35°C	95°F
			ON			40°C	104°F
ON			ON			45°C	113°F
	ON		ON			50°C	122°F
ON	ON		ON			55°C	131°F
		ON	ON			60°C	140°F
ON		ON	ON			65°C	149°F
	ON	ON	ON			70°C	158°F
ON	ON	ON	ON			75°C	167°F
				ON		80°C	176°F
ON				ON		85°C	185°F
	ON			ON		90°C	194°F
ON	ON			ON		95°C	203°F
		ON		ON		100°C	212°F
ON		ON		ON		110°C	230°F
	ON	ON		ON		120°C	248°F
ON	ON	ON		ON		130°C	266°F
			ON	ON		140°C	284°F
ON			ON	ON		150°C	302°F
	ON		ON	ON		160°C	320°F
ON	ON		ON	ON		170°C	338°F
		ON	ON	ON		180°C	356°F
ON		ON	ON	ON		190°C	374°F
	ON	ON	ON	ON		200°C	392°F
ON	ON	ON	ON	ON		210°C	410°F
					ON	220°C	428°F
					ON	230°C	446°F
	ON				ON	240°C	464°F
ON	ON				ON	250°C	482°F
		ON			ON	260°C	500°F
ON		ON			ON	270°C	518°F
	ON	ON			ON	280°C	536°F
ON	ON	ON			ON	290°C	554°F
			ON		ON	300°C	572°F
ON			ON		ON	310°C	590°F
	ON		ON		ON	320°C	608°F
ON	ON		ON		ON	330°C	626°F
		ON	ON		ON	340°C	644°F
ON		ON	ON		ON	350°C	662°F
	ON	ON	ON		ON	360°C	680°F
ON	ON	ON	ON		ON	370°C	698°F
				ON	ON	380°C	716°F
ON				ON	ON	390°C	734°F
	ON			ON	ON	400°C	752°F
ON	ON			ON	ON	410°C	770°F
		ON		ON	ON	420°C	788°F
ON		ON		ON	ON	430°C	806°F
	ON	ON		ON	ON	440°C	824°F
ON	ON	ON		ON	ON	450°C	842°F
			ON	ON	ON	480°C	896°F
ON			ON	ON	ON	500°C	932°F
	ON		ON	ON	ON	520°C	968°F
ON	ON		ON	ON	ON	550°C	1022°F
		ON	ON	ON	ON	580°C	1076°F
ON		ON	ON	ON	ON	600°C	1112°F
	ON	ON	ON	ON	ON	620°C	1148°F
ON	ON	ON	ON	ON	ON	650°C	1202°F

SW2	7	Burnout Protection
	ON	Downscale burnout
		Upscale burnout
SW2	8	Over-Range (see table below)
	ON	No: 2.5% over-range malfunction value
		Yes: 2.5% over-range value is acceptable;
		5% over-range value is a malfunction
Output limit	Over-range/mal.	±2.5% Malfunction ±5%
20 mA	20.5 mA	21 mA
4 mA	3.5 mA	3 mA
0 mA	0 mA	0 mA
10 VDC	10.25 VDC	10.5 VDC
5 VDC	5.125 VDC	5.25 VDC
1 VDC	0.875 VDC	0.75 VDC
0 VDC	0 VDC	0 VDC

API maintains a constant effort to upgrade and improve its products. Specifications are subject to change without notice. Consult factory for your specific requirements.