

Shinko

PAPERLESS RECORDER

GR200 SERIES

Larger Display =Enhanced **Visibility**

View your recording data easily



Portable unit available

Various displays via one-touch key operation

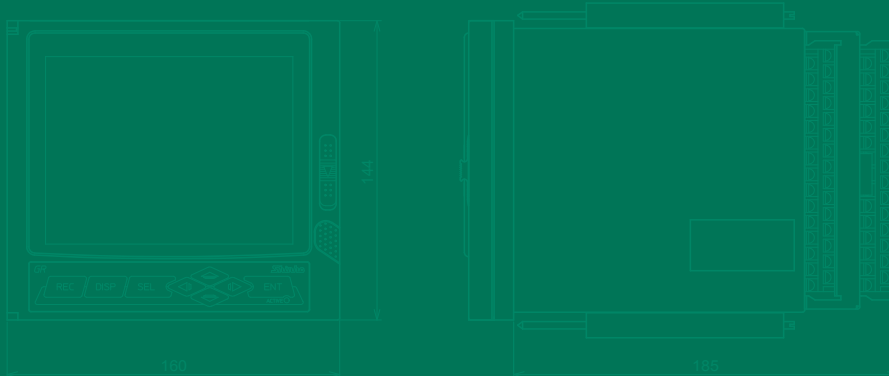

Easy operation

Large indication on a 5.7" display

Recorder

Advantages of using the paperless recorder

■ Your PC can easily manage recorded data

It is easy to store recording data and create reports.
Recording data can be managed using EXCEL.

■ Running costs reduced

Consumables such as chart paper, inks are not necessary, more streamlined operation, save time and money.

■ No malfunctions due to operational abrasion

Malfunctions due to mechanical abrasion are avoidable as motors, gears, etc. which are required for chart paper recorders are no longer necessary.

■ Record more for longer

Using a 1GB CF card, data can be recorded for 6 years. (Using a 30sec recording cycle in the case of 9-point recording)

■ Multi-point recording

9-point, 18-point available

Shinko paperless recorder features ...

- Easy operation
- Large 5.7" display
- Various displays via one-touch key operation

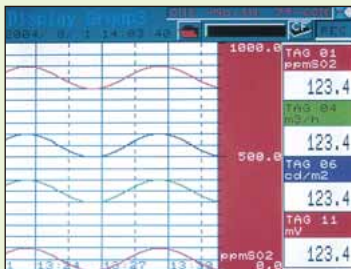

Trend recording (horizontal)

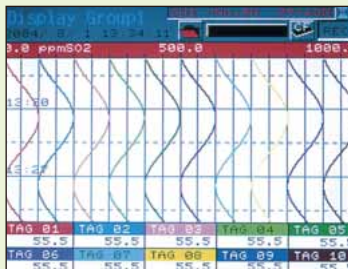

Trend recording (vertical)

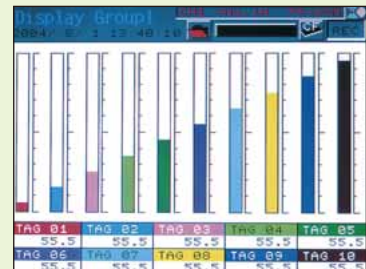

Bar graph display



Digital (totalizing data) display



Analog meter display

■ Other displays available:

- Event summary display
- Ethernet log display
- Parameter display
- Tag display
- Historical trend display

Name of sections



① Status indication

Indicates the display name, calendar, alarm information, recording status, compact flash writing status, compact flash loading status, etc.

② Time indication

Indicates measured time and its scale.

③ Trend indication

Indicates measurement results using a waveform.

④ Channel indication

Indicates measurement values numerically.

⑤ Function keyboard

Recording Start/Stop, indication switching, setting, data indication/alteration, etc. can be conducted.

Models

GR 2 - 0 M 0 0 0 0 0 - 2 0

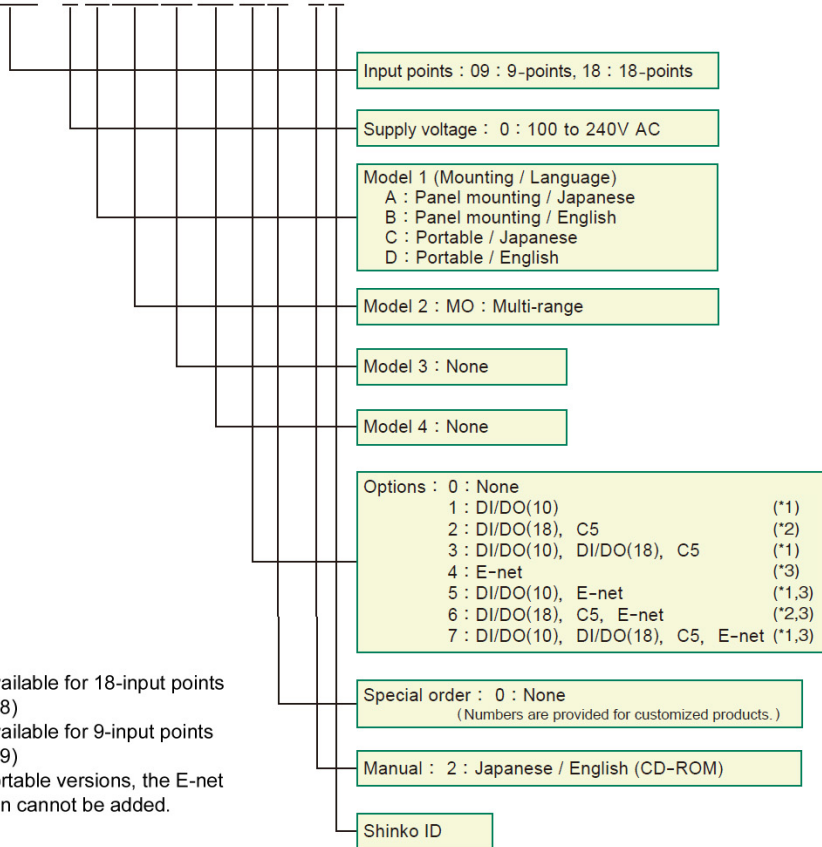

*1: Not available for 18-input points (GR218)

*2: Not available for 9-input points (GR209)

*3: For portable versions, the E-net function cannot be added.

Rating

Input type	Input	Measurement range
Thermocouple	K	-200.0 to 1370.0 °C
	E	-200.0 to 800.0 °C
	J	-200.0 to 1100.0 °C
	T	-200.0 to 400.0 °C
	R	0.0 to 1760 °C
	S	0.0 to 1760 °C
	B	400.0 to 1760.0 °C
	N	0.0 to 1300.0 °C
	W	0.0 to 1760.0 °C
	Fe-Cu·Ni	-200.0 to 900.0 °C
RTD	Cu-Cu·Ni	-200.0 to 400.0 °C
	Platinel	0.0 to 1300.0 °C
	JPt100	-200.0 to 600.0 °C
DC voltage	Pt100	-200.0 to 600.0 °C
	50mV	0.00 to 50.00 mV
	500mV	0.0 to 500.0 mV
	1 to 5V	1.000 to 5.000 V
	0 to 5V	0.000 to 5.000 V

Optional code

Optional code	Contents
DI	5-points (No-voltage contact input)
DO (10)	10-points (1a, contact output)
DO (18)	18-points (open collector output)
C5	Communication RS-485
E-net	Ethernet

Standard specifications

Measurement points	GR209 (input: 9-points), GR218 (input: 18-points) User specified
Input	Multi-range (selectable) • Thermocouple : K, E, J, T, R, S, B, N, W, Fe-Cu·Ni, Cu-Cu·Ni, Platinel • RTD : Pt100, JPt100 • DC Voltage : +50mV, +500mV, +5V • DC current : 10 Ω (Shunt resistor must be connected externally.) (Shunt resistor : Sold separately)
Range setting	Input time and range can be set by key operation.
Scaling setting	Min / Max value & unit of scaling can be set by key operation.
Measurement cycle	100msec (9-points / 18-points)
Max. input voltage	Thermocouple, RTD, DC voltage: ±10V DC (continuous)
Reference junction compensation accuracy (RJ)	K, E, J, T, N, Fe-Cu·Ni, Cu-Cu·Ni, Platinel : ±0.5°C (However, when measuring 0°C or higher) R, S, B, W : ±1.0°C (However, when measuring 0°C or higher)
Input resistance	Thermocouple, DC voltage input : Approx. 1MΩ (Approx. 100kΩ when power-OFF)
Allowable signal source resistance	Thermocouple input : 1kΩ or less RTD input : 10Ω or less per wire (Each resistance of 3-wire has to be stable.)
Recording cycle	1sec to 12 hours
Recording information	Trend data, Event data, Totalizing value data, Set value file
Writing cycle	1min to 12 hours
External recording media	CF card, Max.1GB (BUFFALO RCF-X512MY, RCF-X1GY recommended) CF card not included with the recorder
Data format	FAT16 or FAT
Recording method	ASCII, binary, Selectable by key operation
Display	5.7" TFT color LCD (320 x 240 dots) Indication color: 14 colors (voluntary setting)
Operational display	Display can be switched by key operation. 4 groups are switchable (Max. 10 channels / 1 group). Trend display, Bar graph display, Analog meter display, Digital display, Totalizing data display, Event summary display, Ethernet log display (E-Net option), Parameter display, Tag display, Historical trend display
Alarm	Number of settings: Max. 4 settings for each channel Alarm type : High limit, Low limit Indication : Status (alarm types) is displayed on the Digital display section when an alarm occurs. History is indicated on the alarm summary.
Material	Front panel and case: PC-ABS
Color	Black
Weight	Approx. 1.5kg (Panel mounting) Approx. 1.9kg (Portable)

Attached functions	Recording range arbitrary setting	: Recording range can be set for each channel.	
	Input type setting	: Input type can be set for each channel. However, every 2 channels have the same input type.	
	Skip function	: Skips arbitrary channel display/recording.	
	Trend display	: Time display, Alarm display, compact flash capacity used are indicated.	
	TAG name display	: TAG name is indicated for each channel. (Max. 8 characters).	
	Screen name display	: A maximum of 16 characters are used.	
	Unit creation	: Industrial units can be created easily. (Max. 7 digits, 12 types).	
	Scaling function	: For DC voltage input, scaling is possible.	
	PV shift	: Shifts the PV zero point and changes the PV line angle.	
	Input filter	: Prevents sudden fluctuation of input for each channel.	
Insulation resistance	Burnout function	: If Thermocouple or RTD input is burnt out, then it will scale out to 100% side.	
	Historical trend display	: Data stored in the compact flash can be regenerated and indicated by scrolling the screen.	
	Between each terminal and ground terminal	: 100MΩ, at 500V DC	
	Between input terminals	: 500V AC for 1 min	
	Between power terminal - ground terminal	: 2000V AC for 1 min	
	Between power terminal - input terminal	: 500V AC for 1 min	
	Between input terminal - ground terminal	: 500V AC for 1 min	
	Between alarm terminal (contact output) - ground terminal	: 2000V AC for 1 min	
	Between alarm terminals (contact output)	: 750V AC for 1 min	
	Between alarm terminal (open collector) - ground terminal	: 500V AC for 1 min	
Dielectric strength	Between communication terminal - ground terminal	: 500V AC for 1 min	
	Supply voltage	: 100 to 240V AC, 50/60Hz	
	Allowable voltage fluctuation range	: 90 to 264V AC	
	Ambient temperature	: 0 to 50°C (Panel mounting, without Ethernet function) 0 to 40°C (Panel mounting, with Ethernet function) 0 to 40°C (Portable)	
	Ambient humidity	: 20 to 80%RH (Non-condensing)	
	Mounting	: Panel mounting or portable	
	Dimensions	Panel mounting	: 160 x 144 x 185mm (W x H x D)
		Portable	: 160 x 179 x 206.6mm (W x H x D)

Optional specifications

Alarm output [DI/D0(10)] [DI/D0(18),C5]	User specified
	<ul style="list-style-type: none"> DI/D0(10) : Relay output 10-points + DI input 5-points DI/D0(18), C5: Open collector output 18-points +DI input 5-points + RS485 communication
	Relay output (10-points): 1a contact, contact capacity
	<ul style="list-style-type: none"> D01 : 3A 150V AC (resistive load) or 3A 30V DC (resistive load) D02 to D10 : 3A 240V AC (resistive load) or 3A 30V DC (resistive load)
	No-voltage contact input (5-points):
	ON pulse width : 200msec or more
	OFF pulse width : 200msec or more
	Open collector output (18-points) : 0.1A 30V DC

Communication function [C5]	Communication interface : EIA RS-485
	Protocol : MODBUS (RTU)
	Communication Speed : 9600, 19200bps
Ethernet [E-net]	Transmission speed : 10Mbps
	Transmission method : Baseband
	Max. network length or Max. node interval : 500m (4-level cascade)
	Max. segment length : 100m (Between node-HUB)
	Connecting cable : UTP (Unshielded, twisted pair cable) 22-26AWG
	Protocol : TCP/IP

Optional specifications (Scale: mm)

[Panel mounting]

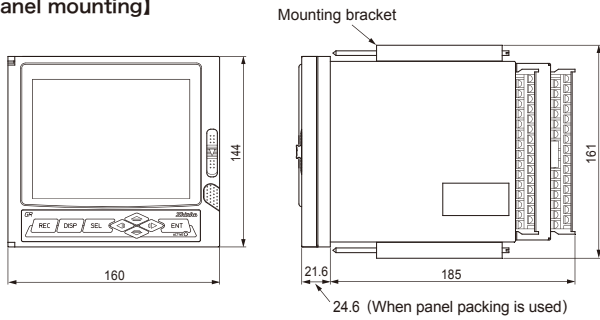

[Portable]

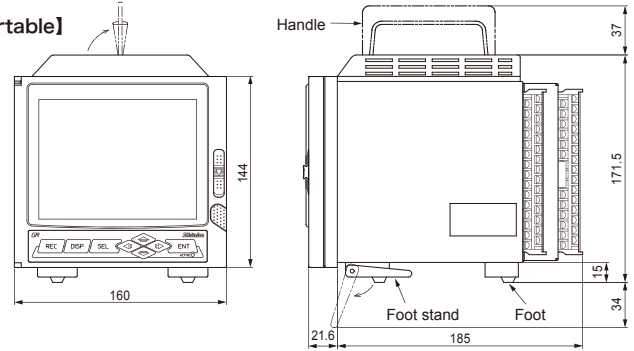

Input terminal arrangement

[9-points input]

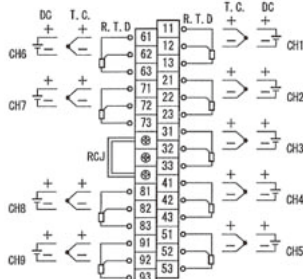

[18-points input]

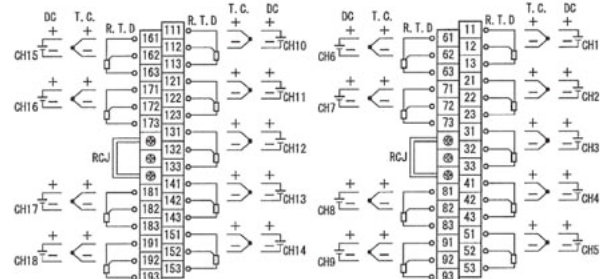

Alarm output / DI input terminals (Input 9-points only)

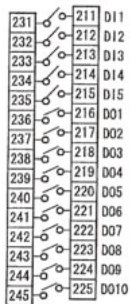

DIO terminals (D-Sub)

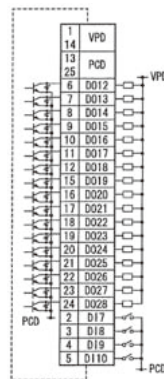

Power terminals

[Panel mounting]

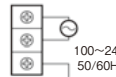

[Portable]

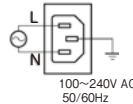

COMMUNICATION DIO TERMINAL

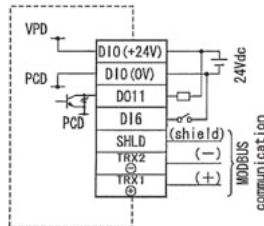

Panel cutout (Scale: mm)

[Single unit mounting]

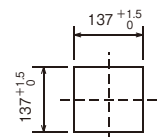

[Lateral close mounting]

